



Avaloir de sol Type: HL80.1 / HL80.1H

Données techniques

Fonction:	Avaloir de sol avec bride d'étanchéité. Tubulure de raccordement pivotant à 90° de l'horizontale à la verticale.
Raccordement:	Ø 50, 75 mm
Tubulure de raccord.:	Tube PE, enfichable et soudable
Débit d'écoulement:	30 litres / minute
Siphon:	Barrage d'eau 50 mm
Capacité de charge:	Max. 300 kg
Temp. du fluide:	Max. +85°C

Données de commande

Art.-No.:	Désignation	Matériaux
HL80.1	Avaloir de sol complet	PE
HL80.1H	Avaloir de sol avec manchette Ø 420 mm complet	Bitume
HL037Pr.1E	Grille 115 x 115 mm	Inox V2A
HL080.5E	Siphon	PP
HL037N.2E	Support de grille 123 x 123 mm	PP
HL01067D	Joint torique 92 mm x 4 mm	EPDM
HL037N.0E	Couvercle de protection carré	ABS
HL03000EN	Couvercle de protection ronde	ABS
HL80K	Corps d'avaloir	PE

Encombres [mm]

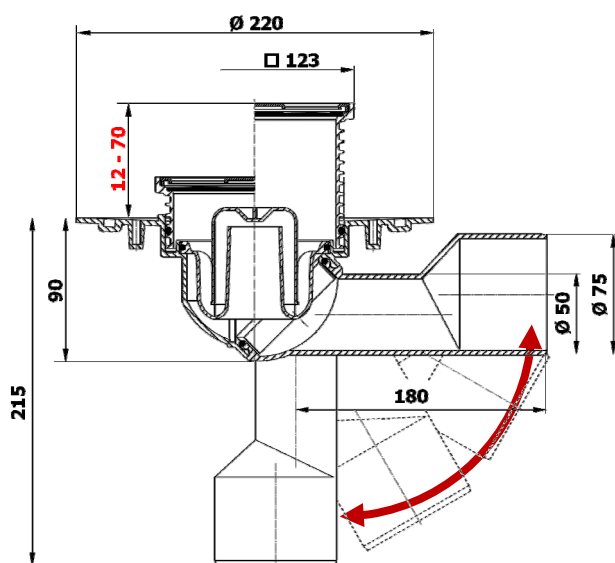

Tubulure de raccordement, pivotant 90°

Nous nous réservons le droit d'apporter toutes modifications à nos produits sans préavis.



HL80.1

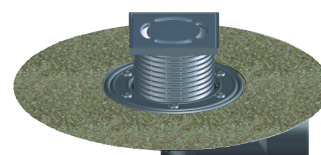

HL80.1H



Grille



Siphon



Support de grille
découpable (12 - 70 mm)



Joint torique



Couvercle de protection
de carré / ronde



Corps d'avaloir



Avaloir de sol Accessoires HL80.1 / HL80.1H

Données de commande

Art.-No.:	Désignation	Matériaux
HL83.H	Garniture d'étanchéité ø bague métallique extérieur = 196 mm Manchette = 500 x 500 mm	Bitume
HL83.M	Garniture d'étanchéité ø bague métallique extérieur = 196 mm Manchette = 400 x 400 mm (pour les résines époxy à 2 composants)	Feuille stratifiée
HL83	Garniture d'étanchéité ø bague métallique extérieur = 196 mm Manchette = 400 x 400 mm	EPDM
HL83.P	Bague d'étanchéité ø extérieur = 290 mm, ø intérieur = 114 mm	PVC
HL83.PP	Bride d'étanchéité ø extérieur = 290 mm, ø intérieur = 114 mm	PP
HL83.0	Élément de fixation ø extérieur = 196 mm, ø intérieur = 114 mm	Inox V2A
HL619	Élément de fixation type FixIT	Inox V2A
HL85N	Élément de rehausse ø bride d'étanchéité = 220 mm ø l'extension = 110 mm H = 200 mm découppable	PP
HL340N	Élément de rehausse ø extérieur = 110 mm H = 100 mm découppable	PP
HL85NH	Élément de rehausse avec manchette ø manchette = 420 mm ø l'extension = 110 mm H = 200 mm découppable	PP Bitume
HL3200	Support de grille 121 x 121 mm	Inox V2A
HL3120-27	Grille 115 x 115 mm	Inox V4A

Options supplémentaires sur demande

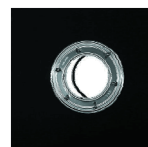

HL83.H, HL83.M, HL83

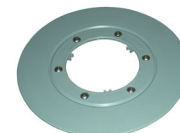

HL83.P, HL83.PP



HL83.0



HL619



HL85N

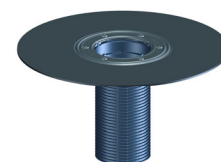

HL85NH



HL340



HL3200

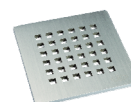

HL3120

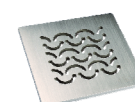

HL3121



HL3122

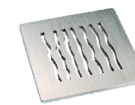

HL3123



HL3124



HL3125



HL3127